

Focus Control Dual Handle for DJI RS Series

Operating Instruction

- Thank you for purchasing SmallRig's product.
- Please read this Operating Instruction carefully.
- Please follow the safety warnings.

Warning

- Please keep the product dry and avoid contact with water or other liquids.
- Do not use the product in high temperature, humid, or dusty environments.
- Keep the product away from flammable materials and avoid prolonged use.
- If any damage is found on the product, please stop using it immediately and contact the after-sales service department for repair or replacement.



Do not disassemble the product. If you suspect there is any problem with the product, please contact the purchasing platform to apply for after-sales processing; Only by connecting the slider on the left side of the DJI stabilizer and tightening the knob with a wrench can the product control the DJI stabilizer correctly; This product is dedicated to controlling DJI RS 2 / RS 3 Pro / RS 4 / RS 4 Pro stabilizer.

In the Box

Stabilizer and coke pot handle × 1

Guarantee Card × 1

Compatibility

DJI RS 2 / DJI RS 3 Pro / DJI RS 4 / DJI RS 4 Pro

Product Dimension

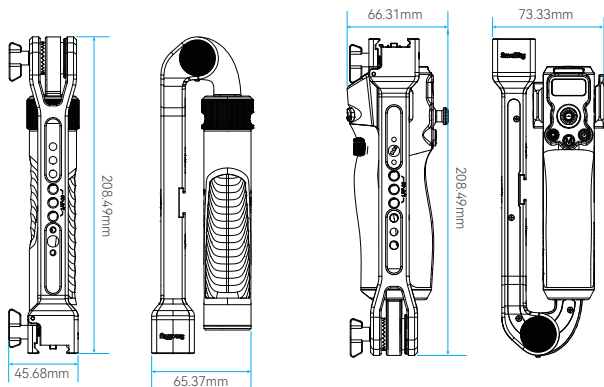

Product Details

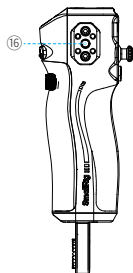
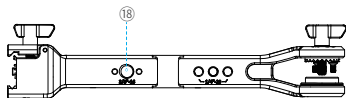
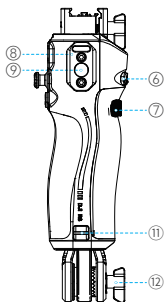
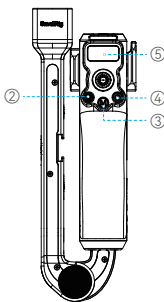
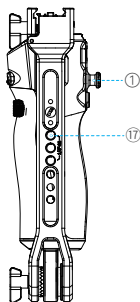
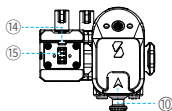

① Joystick

② Record button

③ Mode Switching

④ Sleep Mode

⑤ Display

⑥ Trigger

⑦ Scroll Wheel

⑧ Sliders

⑨ QD interface

⑩ Cold shoe mount

⑪ Wrist strap hole

⑫ Locking knob

⑬ M4 anti-slip screw

⑭ Limit column



⑮ Pin

⑯ 1/4"-20 positioning hole

⑰ 1/4"-20 threaded hole









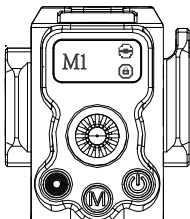

⑱ 3/8"-16 positioning hole

Product Function

- 1. Joystick:** Push the joystick up and down to control the gimbal's pitch axis movement, and push the joystick left and right to control the gimbal's translation axis movement. Joystick calibration method: [Press the trigger button three times in a row, and keep pressing the fourth time. The calibration icon will be displayed on the screen .  Then the joystick will rotate more than 6 circles at the extreme position and stop. The joystick will stay in the middle position for 20 seconds without any operation, waiting for the calibration to complete. If the calibration fails, the calibration error will be displayed  and recalibration is required. If the calibration is successful, it will not be displayed.
- 2. Recording/Photographing Button:** This button has two strokes. Pressing it lightly (the first stroke) controls the camera to autofocus, and pressing it hard (the second stroke) controls the camera to start recording. After recording starts, the recording time is displayed. Pressing it again stops recording, and pressing it hard and long controls the camera to take photos.
- 3. Mode switch (M key):** Single-click to switch modes, double-click to enter/exit vertical shooting mode (RS 4 /RS 4 Pro does not have this function), triple-click to enter/exit 360° rotation mode, long-press the M button to enter/release to exit sports mode, and double-click the trigger button while long-pressing M to lock (exit lock) sports mode.
- 4. Sleep mode:** Single or double-click the power button to enter /exit sleep mode.
- 5. Display screen:** Displays the current mode of the controller. The screen lights up to indicate a normal connection.
- 6. Trigger button (return to center/lock):** Single click: install DJI LiDAR focus rangefinder or Ronin image transmission and turn on, turn on or off ActiveTrack; Double click: return the gimbal to center; Triple click: enter selfie mode; Long press: lock the gimbal's three axes; Long press the trigger button and click the M button to lock or exit the lock gimbal (lock without pressing the trigger button).
- 7. Scroll wheel:** The default function is to control focus/zoom by wire. You can change the settings on the touch screen of the DJI RS 2 / RS 3 Pro / RS 4 / RS 4 Pro stabilizer. You can set it to focus motor, control focus/zoom by wire, adjust the camera ISO, aperture, shutter speed, and control the roll axis, pan axis or pitch axis. You can change the corresponding scroll wheel speed, smoothness, and forward and reverse direction according to the settings on the touch screen;
- 8. Slide bar:** The side slide bar can be expanded with focus wheel, mobile phone holder, monitor and other equipment.
- 9. QD interface:** There is a QD interface on the right slider, which can be used to connect the stabilizer shoulder strap 4118.
- 10. Cold shoe mount:** 2905B can be used to connect a 5-inch monitor. The interface can only bear 1kg and cannot be overloaded.
- 11. Wrist strap hole:** PAC2456B can be used to make holding more comfortable and safer.
- 12. Locking knob:** After loosening the knob, control the angle of the handle.
- 13. M4 anti-slip screw:** must be connected to the left slider of the stabilizer.
- 14. Limit column:** The limit column must correspond to the Nato interface on the DJI stabilizer, otherwise the stabilizer cannot be controlled.
- 15. Pin:** Do not be too violent during disassembly or assembly, otherwise the Pin interface will be damaged.

Icons



- ① " M1 ", " M2 ", " M3 ": Mode indicator, displayed after the stabilizer enters sleep mode " z " "
- ② "  " Icon means connected, "  " icon means connection failed;
- ③ "  " 360 degree rotation mode;
- ④ "  " Vertical shooting mode;
- ⑤ "  " Lock Mode;
- ⑥ "  ", "  " Displayed when entering joystick calibration , "  " and displayed when operating the joystick after calibration fail;  "
- ⑦ "  " Press on/off for a long time.

Product Use

- ① On the left side of the stabilizer, tighten the handle connecting arm with the screw and the mounting knob must be tightened.

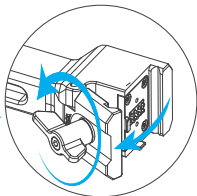
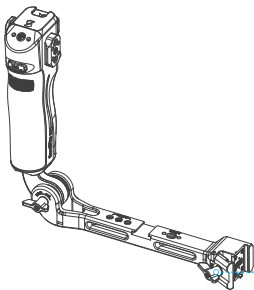

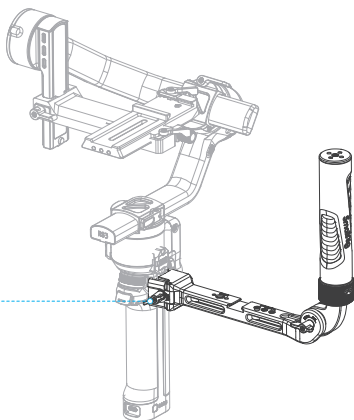
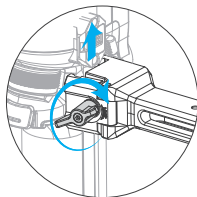
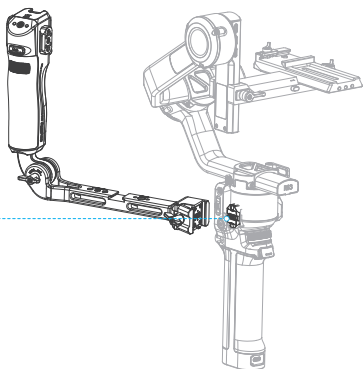
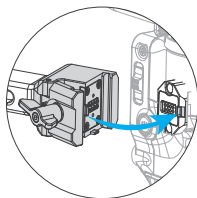

② After the handle is powered on, it will automatically turn on and can be used normally according to the handle functions and stabilizer functions.

Specifications

Product size	520.0 × 66.0 × 209.0mm / 20.5 × 2.6 × 8.2in
Product weight	851.0 ± 5.0g / 30.0 ± 0.2oz
Material	Aluminum alloy, Plastic
Recommended charging ambient temperature	5°C - 40°C / 41°F - 104°F
Rated power	0.5W
Maximum allowable input current	≤ 1A
Allowable input voltage range	9V-17V

Manufacturer Email: support@smallrig.com

Manufacturer: Shenzhen Leqi Innovation Co., Ltd.

Add: Rooms 101, 701, 901, Building 4, Gonglianfuji Innovation Park, No. 58, Ping'an Road, Dafu Community, Guanlan Street, Longhua District, Shenzhen, Guangdong, China.

Consignor: Shenzhen LC Co., Ltd.

Add: Room 201, Building 4, Gonglianfuji Innovation Park, No. 58, Ping'an Road, Dafu Community, Guanlan Street, Longhua District, Shenzhen, Guangdong, China.



FR

Cet appareil se recycle

À DÉPOSER EN MAGASIN

À DÉPOSER EN DÉCHÈTERIE



OU

Points de collecte sur www.quefairemedesdechets.fr
Privilégiez la réparation ou le don de votre appareil !



RoHS



FR

LE TRI + FACILE



Séparez les éléments avant de trier

CE FCC



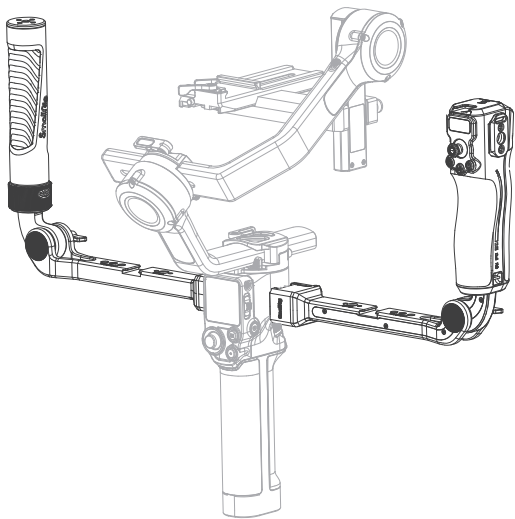

DJI RS 系列稳定器跟焦双手柄

操作指引

感谢您购买 SmallRig 产品。

使用本产品之前，请仔细阅读操作指引。

请注意所有警告提示并遵循使用操作指引的所有指令。

重要提示

- 请保持产品干燥，避免接触水或其他液体。
- 请勿在高温、潮湿或多尘的环境中使用产品。
- 请勿将产品置于易燃物品附近，并避免长时间使用。
- 若发现产品有任何损坏，请立即停止使用并联系售后服务部门进行维修或更换。



请勿拆卸产品，如果您怀疑产品有任何问题，请联络购买平台，申请售后处理；
只有连接DJI稳定器左侧的滑条，且必须通过扳手锁紧旋钮，该产品才可以正确控制DJI稳定器；
该产品专用于控制DJI RS 2 / RS 3 Pro / RS 4 / RS 4 Pro 稳定器。

包装清单

稳定器跟焦双手持 × 1

保修卡 × 1

兼容性

DJI RS 2 / DJI RS 3 Pro / DJI RS 4 / DJI RS 4 Pro

产品尺寸

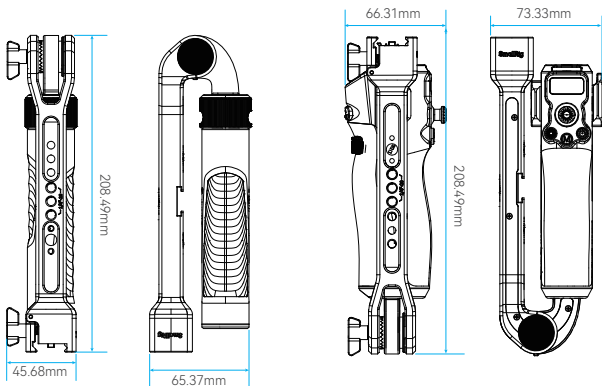

产品介绍

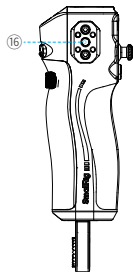
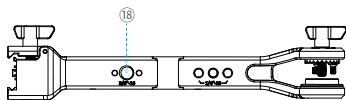
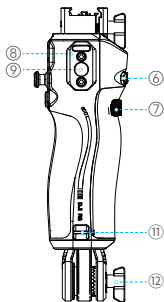
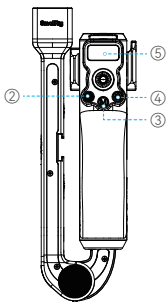
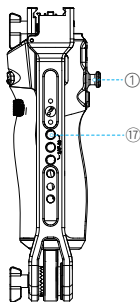
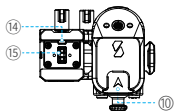

① 摇杆

② 录制键

③ 模式切换

④ 睡眠模式

⑤ 显示屏

⑥ 扳机键

⑦ 滚轮

⑧ 滑条

⑨ QD接口

⑩ 冷靴座

⑪ 腕带孔

⑫ 锁紧旋钮

⑬ M4 防脱螺丝

⑭ 限位柱



⑮ Pin 针

⑯ 1/4"-20 定位孔

⑰ 1/4"-20 螺纹孔









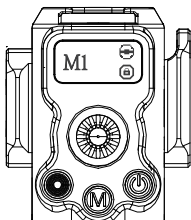

⑱ 3/8"-16 定位孔

产品功能

- 1. 摇杆：**上下推动摇杆控制稳定器俯仰轴运动，左右推动摇杆控制稳定器平移轴运动，摇杆校准方法【连续按扳机键三下，第四下长按，屏幕显示校准图标，】然后摇杆在极限位置旋转6圈以上停止，摇杆停留中间位置20秒不做任何操作，等待校准完成，若校准失败则显示校准错误，需要重新校准，若校准成功则不显示；
- 2. 录像/拍照键：**此键有两段行程，轻按（第一段行程）控制相机自动对焦，重按（第二段行程）控制相机开始录像，录制开始后显示录制时长，再次点击停止录制，重按并长按控制相机拍照。
- 3. 模式切换（M键）：**单击切换模式、双击进入/退出竖拍模式（RS 4 /RS 4 Pro无此功能）、三击进入/退出360°旋转模式、长按M键进入运动模式/松开退出，长按M时同时双击扳机键锁定（退出锁定）运动模式。
- 4. 睡眠模式：**单击或双击开关机键稳定器进入/退出睡眠状态。
- 5. 显示屏：**显示手柄现有模式，屏幕亮起证明连接正常。
- 6. 扳机键（回中/锁定）：**单击：安装DJI LiDAR焦点测距器或Ronin图传并开启，开启或关闭智能跟随；双击：稳定器回中，三击：进入自拍模式，长按不放：锁定稳定器三轴，长按扳机键同时单击M键锁定或退出锁定稳定器（不按扳机键情况下锁定）。
- 7. 滚轮：**默认功能为线控跟焦/变焦，可在稳定器DJI RS 2 / RS 3 Pro / RS 4 / RS 4 Pro触控屏内更改设置，可设置为跟焦电机、线控跟焦/变焦，调节相机ISO、光圈、快门速度，以及控制横滚轴、平移轴或俯仰轴。可根据触屏上的设置，更改对应的拨轮速度、平滑度、正反方向；
- 8. 滑条：**侧面滑条处可拓展跟焦轮、手机支架、监视器等设备，
- 9. QD接口：**右侧滑条处有QD接口，可以连接稳定器肩带4118。
- 10. 冷靴座：**可通过2905B连接监视器5寸监视器，该接口承重仅1kg，不可过载。
- 11. 腕带孔：**可通过PAC2456B让持握更加舒适，且更安全。
- 12. 锁紧旋钮：**旋松旋钮之后，控制手柄的角度。
- 13. M4防脱螺丝：**必须接在稳定器左侧滑条处。
- 14. 限位柱：**限位柱必须与大疆稳定器Nato接口上的对应，否则无法控制稳定器。
- 15. Pin针：**拆装过程中不可太过暴力，否则会损伤Pin针接口。

图标指示



- ① “M1”、“M2”、“M3”：模式指示，稳定器进入休眠后显示“”；
- ② “”代表已经连接，“”代表连接失败；
- ③ “”360度旋转模式
- ④ “”竖拍模式
- ⑤ “”锁定模式
- ⑥ “”、“”进入遥控器校准时显示“”，校准失败后操作遥控器显示“”
- ⑦ “”长按开/关机

产品使用

- ① 在稳定器左侧通过螺丝锁紧手柄连接臂，必须锁紧安装旋钮。

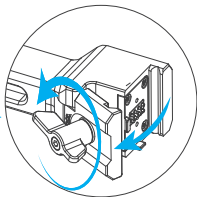
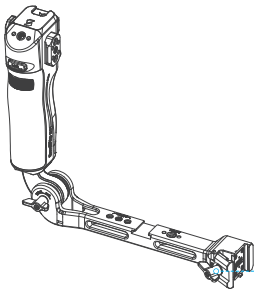

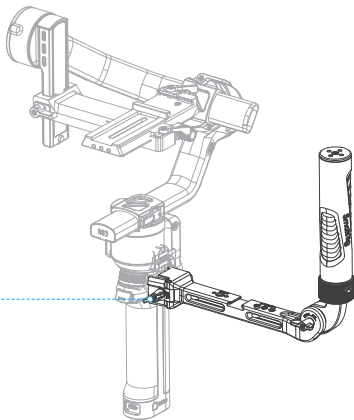
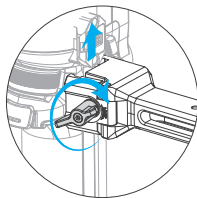
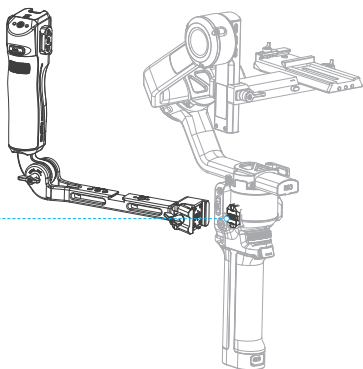
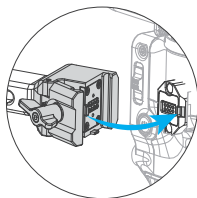

② 手柄通电后，自动开机，可依据手柄功能和稳定器功能正常使用。

产品参数

产品尺寸	520.0 × 66.0 × 209.0mm
产品重量	851.0 ± 5.0g
材料	铝合金 塑胶
建议充电环境温度	5°C ~ 40°C
额定功率	0.5W
最大允许输入电流	≤ 1A
允许输入电压范围	9V-17V

执行标准: GB4943.1-2022

制造商: 深圳市乐其创新股份有限公司

地址: 中国广东省深圳市龙华区观澜街道大富社区平安路58号共联富基创新园4栋101、701、901

委托商: 深圳市乐长科技有限公司

地址: 中国广东省深圳市龙华区观澜街道大富社区平安路58号共联富基创新园4栋201



FR

Cet appareil
se recycle

À DÉPOSER
EN MAGASIN



À DÉPOSER
EN DÉCHÈTERIE



OU

Points de collecte sur www.quefairedemesdechets.fr
Privilégiez la réparation ou le don de votre appareil !

合格证
已检验



RoHS



FR

LE TRI
+ FACILE



Séparez les éléments avant de trier

CE FC

