



## Cage Kit for Canon EOS C400

佳能 EOS C400拓展框套件

4946 / 4947

Operating Instruction / 操作指引

- Thank you for purchasing SmallRig's product.  
感谢您购买 SmallRig 产品。
- Please read this Operating Instruction carefully.  
使用本产品之前，请仔细阅读操作指引。
- Please follow the safety warnings.  
请注意所有警告提示并遵循使用操作指引的所有指令。

**In the Box / 包装清单**

Top Plate 顶板	× 1	Left-Side Plate 左侧板	× 1	Right-Side Plate 右侧板	× 1
Baseplate 底板	× 1	V-mount Plate Kit V口供电板套件	× 1	15mm Dual Rod Base 15mm双管底座	× 1
15mm Dual Rod 15mm双管	× 1	LCD Sun Shade 遮光罩	× 1	Operating Instruction 操作指引	× 1
Handle Locking Knob 手柄锁紧旋钮	× 1	Guarantee Card 保修卡	× 1		
D-Tap to 4-Pin Power Cable D-Tap转4Pin供电线	× 1	C to C Handle Extension Cable C to C手柄延长线	× 1		
Extension Module for the Original Handle 原厂手柄拓展件	× 1				
NATO Rail for LCD Monitor Extension LCD延长滑槽	× 1				

**Specifications / 产品参数**

Product Dimensions 产品尺寸	7.9 × 11.8 × 6.3in 201.2 × 300 × 160mm
Product Weight 产品重量	50.7 ± 0.2oz 1439.5 ± 5.0g
Material (s) 主要材质	Aluminium Alloy, Silicone, Stainless Steel 铝合金, 硅胶, 不锈钢

**In the Box / 包装清单**

Top Plate 顶板	× 1	Left-Side Plate 左侧板	× 1	Right-Side Plate 右侧板	× 1
Baseplate 底板	× 1	Cheese Backplate Cheese背板	× 1	LCD Sun Shade 遮光罩	× 1
Handle Locking Knob 手柄锁紧旋钮			× 1	Operating Instruction 操作指引	× 1
Extension Module for the Original Handle 原厂手柄拓展件			× 1	Guarantee Card 保修卡	× 1

**Specifications / 产品参数**

Product Dimensions 产品尺寸	6.8 × 6.3 × 5.39in 172.0 × 160.0 × 137.0mm
Product Weight 产品重量	24 ± 0.2oz 680 ± 5.0g
Material (s) 主要材质	Aluminium Alloy 铝合金

## Product details / 产品介绍

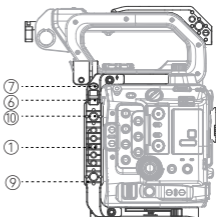
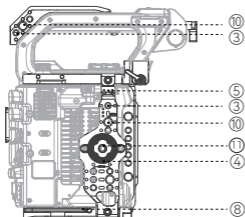
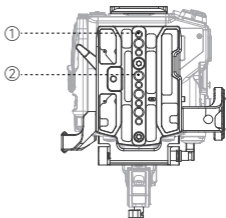
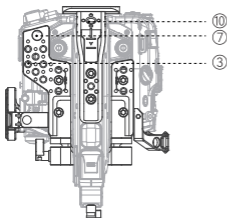

- |  |  |  |
|--|--|--|
| ① 1/4"-20 Threaded Hole<br>1/4"-20 螺纹孔 | ② 3/8"-16 Threaded Hole<br>3/8"-16 螺纹孔 | ③ 1/4"-20 Locating Hole<br>1/4"-20 定位孔 |
| ④ ARRI Rosette<br>阿莱规格齿轮               | ⑤ H18 Cold Shoe<br>H18冷靴               | ⑥ Strap Slot<br>肩带孔                    |
| ⑦ QD Socket<br>QD接口                    | ⑧ Allen Wrench<br>六角扳手                 | ⑨ H21 NATO Rail<br>H21滑条               |
| ⑩ ARRI 3/8"-16 Locating Hole<br>阿莱定位孔  |  | ⑪ M6 Threaded Hole<br>M6螺纹孔            |



## Top Plate / Baseplate / Side Plate Installation

### 顶板 / 底板 / 侧板安装步骤

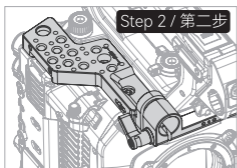

Please install in the following order:  
baseplate, top plate, side plates.  
请按照底板, 顶板, 侧板的顺序安装

### Step 3 / 第三步

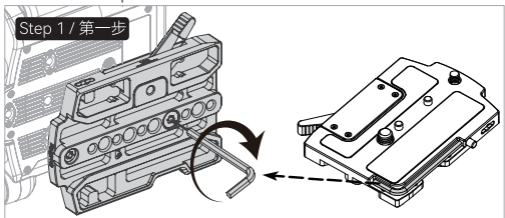
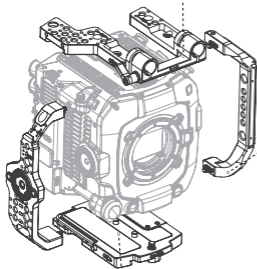
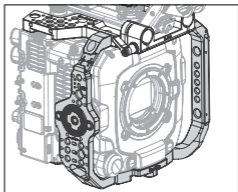

## Handle Extension Plate / Cheese Backplate Installation 原厂手柄拓展件 / Cheese背板

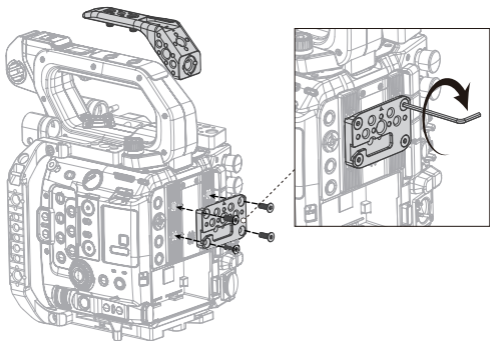

## LCD Sun Shade Installation / 遮光罩安装步骤

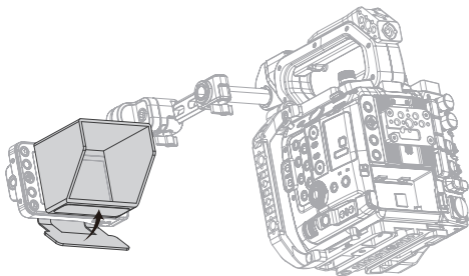

## Handle Locking Knob Installation

### 手柄旋钮安装步骤

#### Step 1 / 第一步



\* Please remove the original screws first, and then mount with the handle Locking Knob.

请先取下原厂螺丝，再安装手柄旋钮

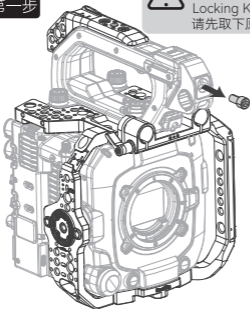

#### Step 2 / 第二步

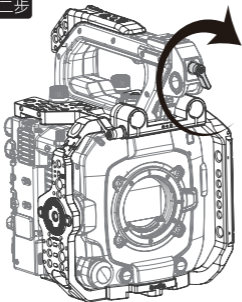

## Adjustable Plate Installation / 调节背板安装步骤

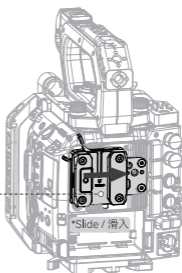
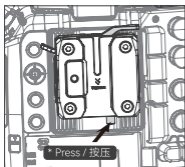

\*Please press the anti-drop button first,  
then slide it out for disassembly  
拆卸时需先按压防脱按键，再滑出拆卸

## V-Mount Plate Installation / V口电池板

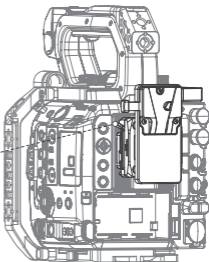
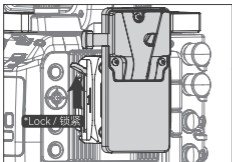

# 15mm Dual Rod Base / 15mm Dual Rod 15mm双管底座/ 15mm双管

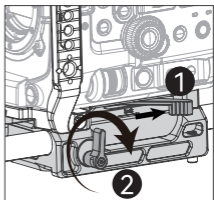
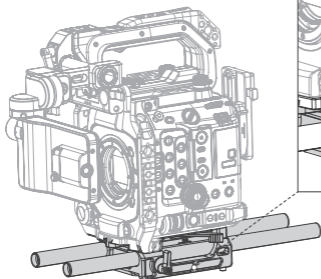

\* Please press the anti-drop button first, then slide it out for disassembly  
拆卸时需先按压防脱按键，再滑出拆卸

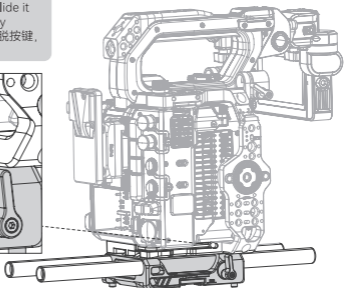
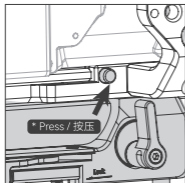

## NATO Rail Installation / NATO延长件安装步骤

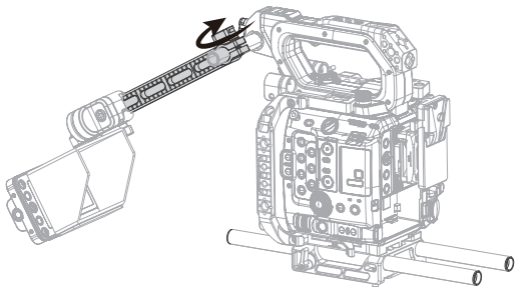

## D-Tap to 4-Pin Power Cable Installation

### D-Tap线安装步骤

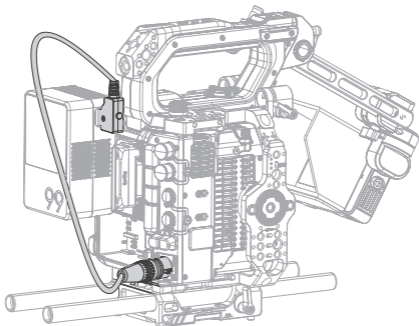

## Extension Module for the Original Handle Installation 手柄延长线安装步骤

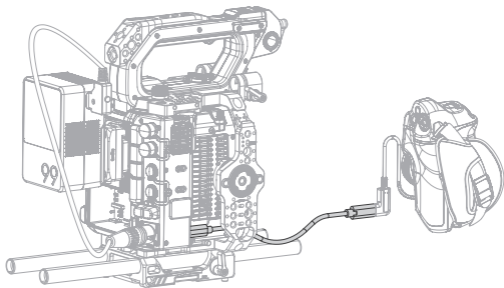

Scan the QR code to access detailed installation videos.  
扫描二维码即可观看详细的安装视频



中文版本



EN Version

Manufacturer Email: support@smallrig.com

Manufacturer: Shenzhen Leqi Innovation Co., Ltd.

Add: Rooms 103, 501 and 601, Building 5, Fenghe Industrial Park, Nos. 1301-50 Guangguang Road, Longhua District, Shenzhen, Guangdong, China.

制造商: 深圳市乐其创新股份有限公司

地址: 中国广东省深圳市龙华区观澜街道新澜社区观光路 1301-50 号丰和工业园  
厂房 5 栋 103、501、601

Consignor: Shenzhen LC Co., Ltd.

Add: Rooms 602, Building 5, Fenghe Industrial Park, No. 1301-50 Guangguang Road, Xinlan Community, Guanlan Street, Longhua District, Shenzhen, Guangdong, China.

委托商: 深圳市乐长科技有限公司

地址: 中国广东省深圳市龙华区观澜街道新澜社区观光路 1301-50 号丰和工业园  
厂房 5 栋 602

执行标准: GB/T 26572-2011

LQ-P1414-18

中国制造

Made in China

合格证  
已检验

RoHS



FR

LE TRI  
+ FACILE



Boîte 1



Cable 1



Papier 5



BAC DE TRI

Séparez les éléments avant de trier

RECICLA  
Al Azul

