

# SmallRig

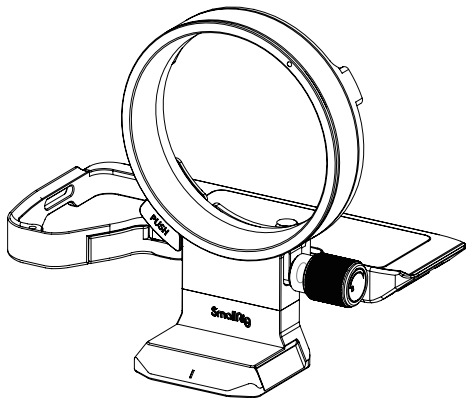

**Rotatable Horizontal-to-Vertical  
Mount Plate Kit for Sony  
Alpha 7R V / Alpha 7 IV / Alpha 7S III / Alpha 7R IV**

User Manual

In order to ensure user's safety and prevent the product damages caused by any improper use, please carefully read the "Warnings" below and properly keep this User Manual for future reference.

## Foreword

Thank you for purchasing SmallRig's product.

## Warnings

- Please read this User Manual carefully.
- Please keep the user manual properly, and be sure to attach this user manual when handing over the product to others.
- Please heed all warnings and follow all instructions in the owner's manual.

## Intended Use

- Please read this User Manual carefully, especially the "Warnings".
- Please use or store the product in the environment mentioned herein.
- It will be regarded as improper use when the users are not correctly following the user manual or using the product under the specific working condition.

## In the Box

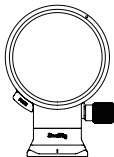

Lens Ring Mounting Plate  
for Vertical and Horizontal × 1

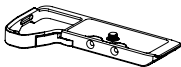

Baseplate × 1



Allen Wrench × 1

## Product Detail Display

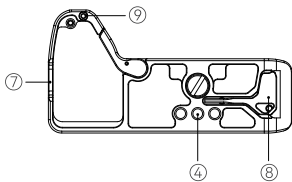
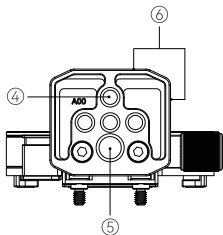
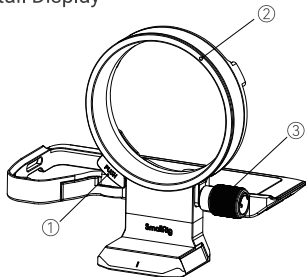

- |                         |                         |  |
|-------------------------|-------------------------|--|
| ① Lens Release Button   | ② Mounting Index        | ③ Unlock Knob                                    |
| ④ 1/4"-20 Threaded Hole | ⑤ 3/8"-16 Threaded Hole | ⑥ Arca-Swiss / Manfrotto RC2 Quick Release Plate |
| ⑦ Strap Slot            | ⑧ Dual-Head Wrench      | ⑨ Anti-Twist Pin                                 |

## Product Installation Introduction

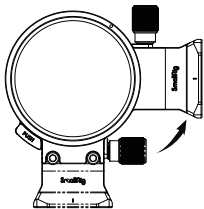

1. Place the Lens Ring Mounting Plate to the state as the picture shown.

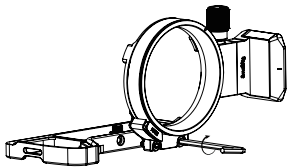

2. Use the hex wrench to mount the Lens Ring Mounting Plate onto the Baseplate.

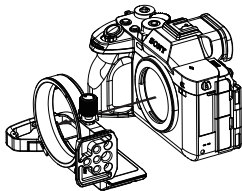

3. Remove the camera body cap and slide the camera into the assembled mount plate kit.

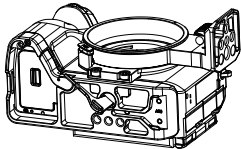

4. Use the included Dual-Head Wrench to secure the bottom 1/4"-20 screw of the baseplate.

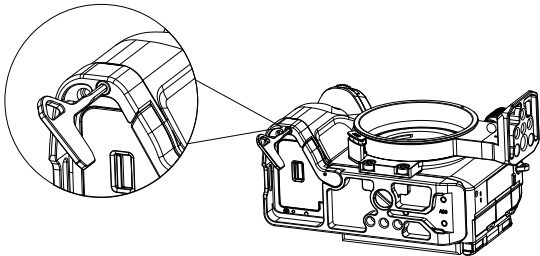

5. Use the included Dual-Head Wrench to remove the Anti-Twist Pin.

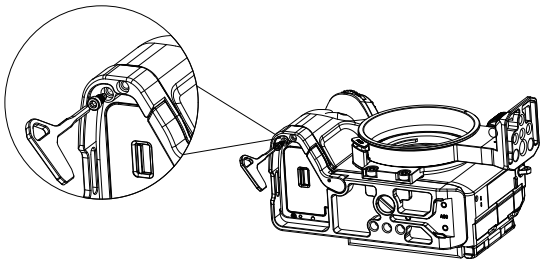

6. Install the Anti-Twist Pin to the adjacent hole and secure it.

## Instruction for use

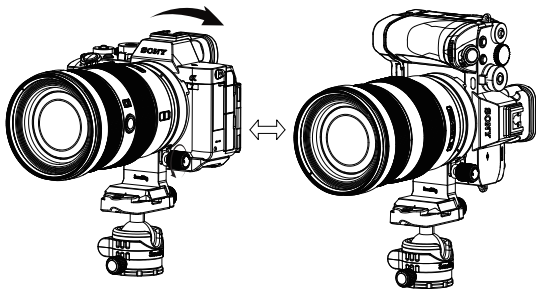

Turn the camera around via loosening the Unlock Knob to switch the modes between horizontal and vertical shooting.

## Caution

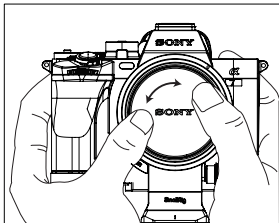

After the installation, please refer to the figure to remove and install the body cap.

## Compatibility

Sony Alpha 7R V  
Sony Alpha 7R IV  
Sony Alpha 7 IV  
Sony Alpha 7S III

## Specifications

Product Dimensions: 107.5 × 80.4 × 28.7mm  
Product Weight: 185.0 ± 5.0g  
Material(s): Aluminum Alloy, Stainless Steel

# SmallRig

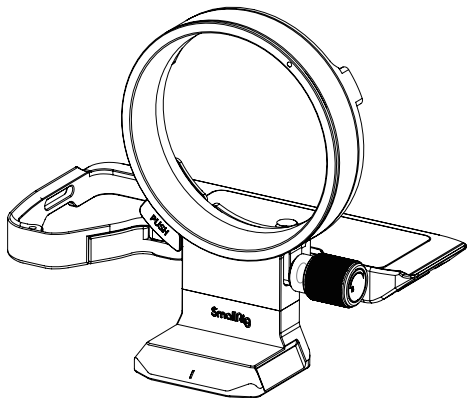

索尼

Alpha 7R V / Alpha 7 IV / Alpha 7S III / Alpha 7R IV

可旋转横竖拍安装板套件

用户手册



为了保障使用者的安全以及防止不当使用导致产品损坏，请认真阅读本用户手册，并妥善保管，以备随时查阅。

## 前言

感谢您购买 SmallRig 产品。

## 重要提示

- 使用本产品之前，请仔细阅读用户手册。
- 请妥善保管用户手册，将产品交给他人使用时，请务必附带本用户手册。
- 请注意所有警告提示并遵循使用用户手册内的所有指令。

## 设备使用规范

- 请仔细阅读本用户手册，特别是“重要提示”部分。
- 请在本用户手册规定的环境条件下使用或保存本产品。
- 如不按照本用户手册使用产品，或不遵守规定的工作和保存条件，将被视为违规使用。

## 包装清单

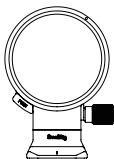

竖拍转接环 × 1

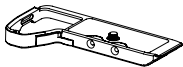

底板 × 1



六角扳手 × 1

## 产品介绍

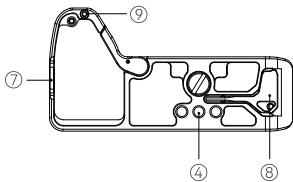
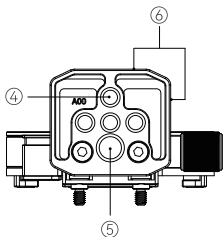
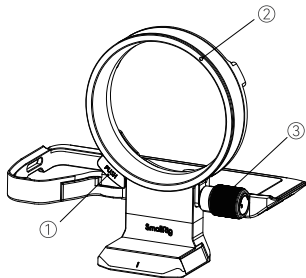

① 镜头解锁按钮

② 安装标记

③ 锁紧旋钮

④ 1/4"-20螺纹孔

⑤ 3/8"-16螺纹孔

⑥ 阿卡 / 曼富图  
RC2快装板

⑦ 腕带孔

⑧ 双头扳手

⑨ 防偏转销钉

## 安装步骤

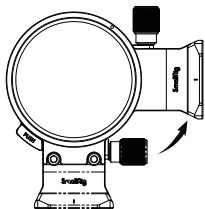

1. 将竖拍转接环展开至如图状态。

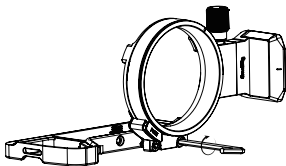

2. 使用六角扳手将竖拍转接环安装至底板。

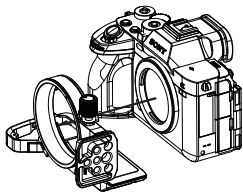

3. 取下相机机身盖，将相机滑入安装。

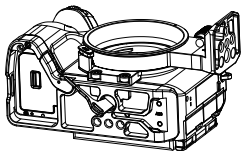

4. 使用双头扳手固定底部1/4"-20螺丝。

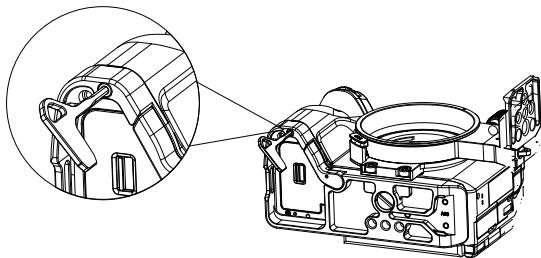

5. 使用双头扳手取下防偏转销钉。

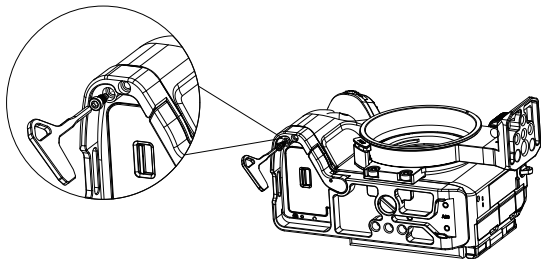

6. 将防偏转销钉安装至相邻孔位并锁紧。

## 使用说明

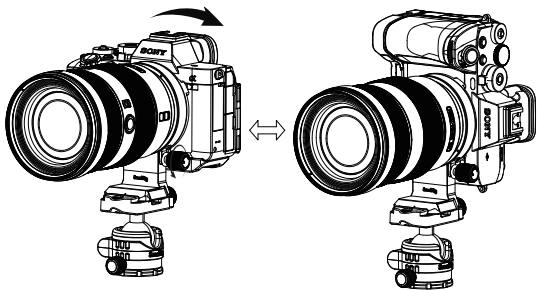

通过拧松旋钮旋转相机即可进行横竖拍切换。

## 注意事项

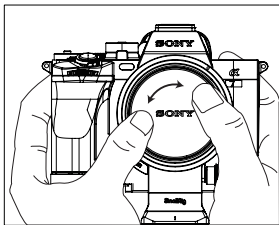

安装竖拍板之后，请参考如图方式取装机身盖。

## 适配性

索尼 Alpha 7R V

索尼 Alpha 7R IV

索尼 Alpha 7 IV

索尼 Alpha 7S III

## 产品参数

产品尺寸: 107.5 × 80.4 × 28.7mm

产品重量: 185.0 ± 5.0g

材质: 铝合金、不锈钢