



Cage Kit for Canon EOS C400

佳能 EOS C400拓展框套件

4946 / 4947

Operating Instruction / 操作指引

- Thank you for purchasing SmallRig's product.
感谢您购买 SmallRig 产品。
- Please read this Operating Instruction carefully.
使用本产品之前，请仔细阅读操作指引。
- Please follow the safety warnings.
请注意所有警告提示并遵循使用操作指引的所有指令。

In the Box / 包装清单

Top Plate 顶板	× 1	Left-Side Plate 左侧板	× 1	Right-Side Plate 右侧板	× 1
Baseplate 底板	× 1	V-mount Plate Kit V口供电板套件	× 1	15mm Dual Rod Base 15mm双管底座	× 1
15mm Dual Rod 15mm双管	× 1	LCD Sun Shade 遮光罩	× 1	Operating Instruction 操作指引	× 1
Handle Locking Knob 手柄锁紧旋钮	× 1	Guarantee Card 保修卡			× 1
D-Tap to 4-Pin Power Cable D-Tap转4Pin供电线	× 1	C to C Handle Extension Cable C to C手柄延长线			× 1
Extension Module for the Original Handle 原厂手柄拓展件					× 1
NATO Rail for LCD Monitor Extension LCD延长滑槽					× 1

Specifications / 产品参数

Product Dimensions 产品尺寸	7.9 × 11.8 × 6.3in 201.2 × 300 × 160mm
Product Weight 产品重量	50.7 ± 0.2oz 1439.5 ± 5.0g
Material (s) 主要材质	Aluminium Alloy, Silicone, Stainless Steel 铝合金, 硅胶, 不锈钢

In the Box / 包装清单

Top Plate 顶板	× 1	Left-Side Plate 左侧板	× 1	Right-Side Plate 右侧板	× 1
Baseplate 底板	× 1	Cheese Backplate Cheese背板	× 1	LCD Sun Shade 遮光罩	× 1
Handle Locking Knob 手柄锁紧旋钮			× 1	Operating Instruction 操作指引	× 1
Extension Module for the Original Handle 原厂手柄拓展件			× 1	Guarantee Card 保修卡	× 1

Specifications / 产品参数

Product Dimensions 产品尺寸	6.8 × 6.3 × 5.39in 172.0 × 160.0 × 137.0mm
Product Weight 产品重量	24 ± 0.2oz 680 ± 5.0g
Material (s) 主要材质	Aluminium Alloy 铝合金

Product details / 产品介绍

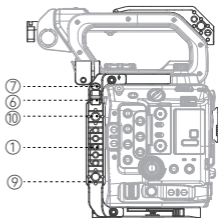
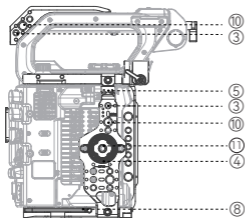
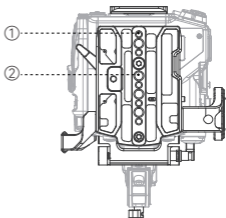
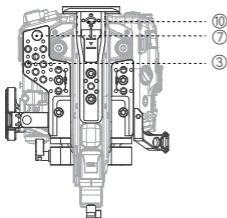

- | | | |
|--|--|--|
| ① 1/4"-20 Threaded Hole
1/4"-20 螺纹孔 | ② 3/8"-16 Threaded Hole
3/8"-16 螺纹孔 | ③ 1/4"-20 Locating Hole
1/4"-20 定位孔 |
| ④ ARRI Rosette
阿莱规格齿轮 | ⑤ H18 Cold Shoe
H18冷靴 | ⑥ Strap Slot
肩带孔 |
| ⑦ QD Socket
QD接口 | ⑧ Allen Wrench
六角扳手 | ⑨ H21 NATO Rail
H21滑条 |
| ⑩ ARRI 3/8"-16 Locating Hole
阿莱定位孔 | | ⑪ M6 Threaded Hole
M6螺纹孔 |

Top Plate / Baseplate / Side Plate Installation

顶板 / 底板 / 侧板安装步骤

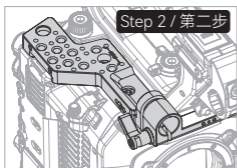

Please install in the following order:
baseplate, top plate, side plates.

请按照底板，顶板，侧板的顺序安装

Step 3 / 第三步

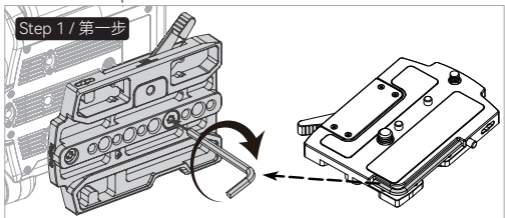
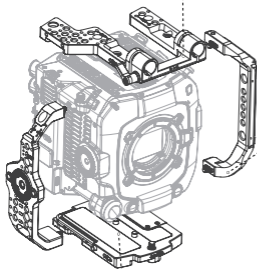
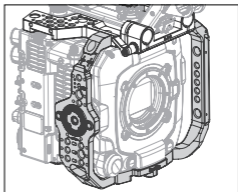

Handle Extension Plate / Cheese Backplate Installation 原厂手柄拓展件 / Cheese背板

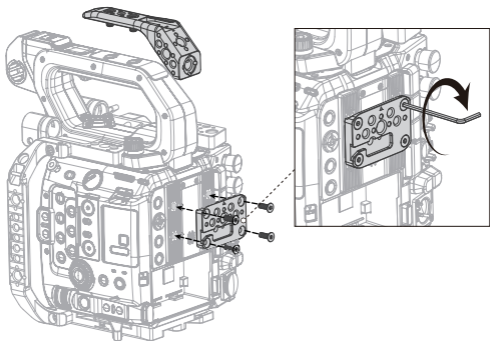

LCD Sun Shade Installation / 遮光罩安装步骤

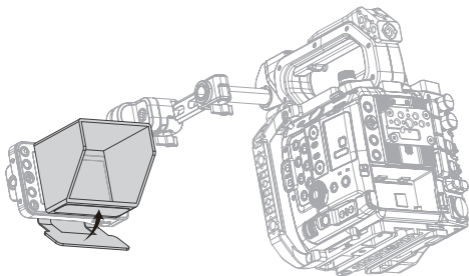

Handle Locking Knob Installation

手柄旋钮安装步骤

Step 1 / 第一步

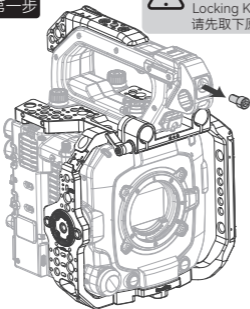

* Please remove the original screws first, and then mount with the handle Locking Knob.

请先取下原厂螺丝，再安装手柄旋钮

Step 2 / 第二步

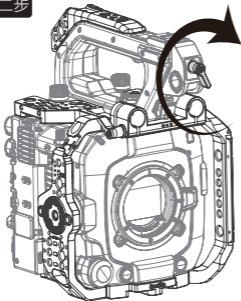

Adjustable Plate Installation / 调节背板安装步骤

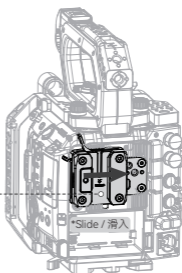
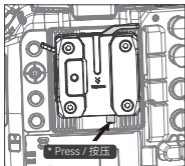

*Please press the anti-drop button first,
then slide it out for disassembly
拆卸时需先按压防脱按键，再滑出拆卸

V-Mount Plate Installation / V口电池板

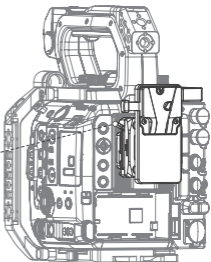
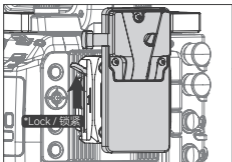

15mm Dual Rod Base / 15mm Dual Rod

15mm双管底座/ 15mm双管

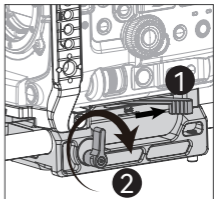
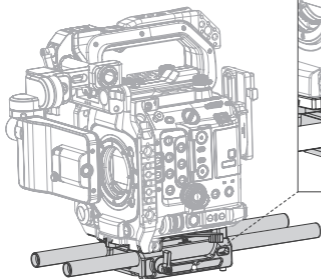

* Please press the anti-drop button first, then slide it out for disassembly
拆卸时需先按压防脱按键，再滑出拆卸

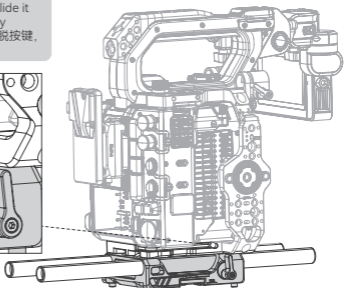
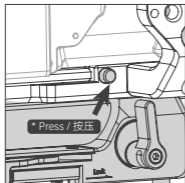

NATO Rail Installation / NATO延长件安装步骤

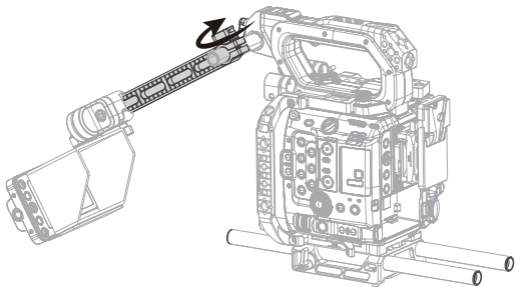

D-Tap to 4-Pin Power Cable Installation

D-Tap线安装步骤

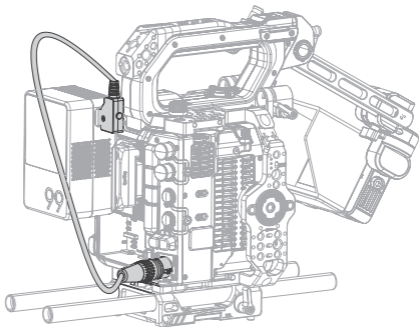

Extension Module for the Original Handle Installation 手柄延长线安装步骤

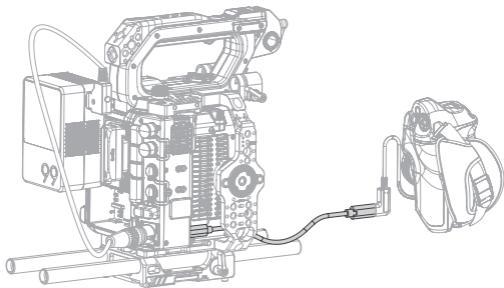

Scan the QR code to access detailed installation videos.
扫描二维码即可观看详细的安装视频



中文版本



EN Version

Manufacturer Email: support@smallrig.com

Manufacturer: Shenzhen Leqi Innovation Co., Ltd.

Add: Rooms 103, 501 and 601, Building 5, Fenghe Industrial Park, Nos. 1301-50 Guangguang Road, Longhua District, Shenzhen, Guangdong, China.

制造商: 深圳市乐其创新股份有限公司

地址: 中国广东省深圳市龙华区观澜街道新澜社区观光路 1301-50 号丰和工业园
厂房 5 栋 103、501、601

Consignor: Shenzhen LC Co., Ltd.

Add: Rooms 602, Building 5, Fenghe Industrial Park, No. 1301-50 Guangguang Road, Xinlan Community, Guanlan Street, Longhua District, Shenzhen, Guangdong, China.

委托商: 深圳市乐长科技有限公司

地址: 中国广东省深圳市龙华区观澜街道新澜社区观光路 1301-50 号丰和工业园
厂房 5 栋 602

执行标准: GB/T 26572-2011

LQ-P1414-18

中国制造

Made in China



RoHS



Séparez les éléments avant de trier

